

Warmup[®]

The world's **best-selling** floor heating brand[™]

Installation Manual: Foil Heaters

TECHNICAL HELPLINE
0345-345-2288



Complete and submit the warranty form online at www.warmup.co.uk

IMPORTANT

Read this manual before attempting to install your foil heater. Incorrect installation could damage the heater and will invalidate your warranty.

Contents

Page	②	Introduction Items Required How to select the correct heater
	③	Important Information DON'T ALWAYS
	⑤	About the product Construction Technical Specification Installation Examples
	⑥	Product Data
	⑦	Compatible Wood / Laminates Compatible Insulation Cutting and Turning the Mat
	⑧	Electrical Requirements Testing the heater
	⑨	Step 1: Planning Your Installation Step 2: Check and prepare the subfloor
	⑩	Step 3: Laying out your heating mats
	⑪	Step 4: Installing the floor sensor Step 5: Installing the flooring Step 6: Connect the thermostat
	⑫	Floor Plan
	⑬	Warranty
	⑭	Control Card

These Installation instructions are NOT intended to replace or supersede the installation instructions provided by the manufacturer of the wood flooring.

All sets of installation instructions should be complied with.

In the event of any contradiction between the Warmup® foil instructions and the flooring instructions contact Warmup for clarity on how to proceed.

If these instructions are followed you should have no problems.

However, if you do require help at any stage, please call our 24hr helpline:

Warmup Technical Helpline: 0345 345 2288

Introduction

This manual contains **IMPORTANT** information regarding the safe use and installation of your foil heaters. Please read through the entire manual carefully before you install or use the product.

Items required

Before installing your new Warmup® Foil heater, be sure that you have the following additional parts:

- The customized installation plan (or layout)
- A Warmup® Thermostat
- Digital ohm meter (multi-meter)
- 30mA RCD
- Electrical Junction box
- Electrical conduit
- Insulation material

Warmup® Foil mats must be fitted directly on top of the Insulation, and directly under the wood laminate flooring.

Before installation always check the subfloor has adequate thermal insulation. This is particularly important where the foil heaters will be used as a primary heat source. A heat loss calculation **MUST** be carried out to ensure that the product will provide enough heat for your room.

See page 7 for information on suitable insulation materials.

How to select the correct heater or heater combination

Calculate the area of the floor to be heated. This is the total floor area minus any permanent fixtures.

$$\text{Length} \times \text{width} = \text{m}^2$$

Select the heating mat or combination of mats closest in size to the area you want to heat. See page 6 for the full range of heater sizes. .

Remember

Heaters cannot overlap

Heaters must be connected in parallel

A single thermostat can control up to handle loads up to 16 Amps.

Important Information

DON'T:

- DON'T** use the foil heating mats with glued locking systems or laminates that have an underpad or cushion material pre-attached to its underside.
- DON'T** install the foil heater up steps.
- DON'T** install over floors that have traces of moisture, are uneven, have carpets or parquet floor.
- DON'T** leave insulating materials such as bean bags; linen or towels on the floor surface.
- DON'T** overlap heating mats, fold or wrinkle the foil heating mats.
- DON'T** place heavy/sharp tools (or any other potentially damaging object) on top of the heating mats.
- DON'T** walk unnecessarily on the foil heating mats.
- DON'T** install mats when the room temperature is below -5°C.
- DON'T** install foil heating mats anywhere except inside buildings.
- DON'T** install foil mats under walls or partitions, or in areas under heavy cabinets, closets, or fixtures (toilets, sinks, tubs, etc.).
- DON'T** install foil mats within approximately 50mm of any heat conductive building part, such as cold water pipes.
- DON'T** install foil mats within 20mm of one another, 50mm of any wall or 100mm of a fireplace or hot water pipe.
- DON'T** install foil heating mats under wooden floor, if the floor is thicker than 18mm.
- DON'T** use this heater directly under any floor covering other than wood or laminate.
- DON'T** place items on the floor surface which will stop the air flow or not allow heat to rise into the room.
- DON'T** install electrical cables or pipes under the floor with the foil heating mats.
- DON'T** use cellulose insulation.
- DON'T** install the heating mats direct contact with a cement or concrete slab.
The heater must be installed on top of a suitable soft Insulation material.

WARNING

Once the foil heating mat has been installed avoid all traffic over the mat until the floor has been laid.

If the floor is not being laid immediately, all heating mats must be protected with cardboard to prevent damage. Immediately prior to the floor being laid, test the heating mat to ensure it has not been damaged.

Important Information

ALWAYS:

- ALWAYS** check with the manufacturer of your flooring, that their products are compatible with electric floor heating systems.
- ALWAYS** operate the heating mat with a Warmup® floor sensor thermostat to ensure the floor does not exceed the maximum temperature of the wood laminate (usually 27°C).
- ALWAYS** ensure all earth leads are connected to the earth ring.
- ALWAYS** ensure that the system is operated with a Warmup® thermostat in floor sensor mode.
- ALWAYS** connect all cold wire leads from the foil heating mats in parallel inside an electrical junction box.
- ALWAYS** zone each room with a foil heating system with its own thermostat controller. This allows each room to be controlled individually saving you energy by only heating the zone when required. Each Warmup® thermostat has a maximum capacity of 16 Amps.
- ALWAYS** ensure that no sharp edges (e.g. metal-edged laminate locking systems) come in contact with the foil heating.
- ALWAYS** install a soft insulation / underlay below the heating mats to prevent damage when the weight of the floor furniture etc is added. Make sure unavoidable wooden floor movements will not harm the foil mats .
- ALWAYS** ensure that a heat loss calculation has been carried out and heating requirements have been met if you are using the Foil heating system as a primary source of heating.
- ALWAYS** ensure that the heaters are protected by a 30mA RCD.
- ALWAYS** ensure that the control card at the back of the manual is completed and fixed at the main consumer unit along with any plans and electrical test records. As per the current BS7671:2008 17th Edition wiring regulations.
- ALWAYS** use the foil strips provided to bridge any gaps when cutting and turning the mats. This is important to keep the earth intact.

CAUTION !

Care must be taken to avoid thermal blocks.

Thermal blocks are caused when an object placed on the floor prevents the heat from being transferred into the air. Thermal blocks can cause damage to the flooring. Examples of items that can cause thermal blocks are rubber backed rugs, solid based furniture, floor cushions, beanbags etc.

About the Product

Construction:

The Warmup® Foil system is constructed using dual core fluoropolymer insulated heating cables sandwiched between two layers of specially reinforced aluminium foil.

The aluminium foil along with the uniform spacing of the heating elements ensures even heat distribution. The heating elements are connected to the power supply cable, which exits the mat from one corner.

Technical Specification:

Voltage	230 Vac - 50 Hz
Standard Wattage	80W /m ² and 140W /m ²
Mat Width	500mm
Heating Cable Spacing	50mm
Cold Lead length	3m
IP Rating	IPX7
Tested in accordance with	EN60335-1:2002, EN60335-2-96:2002 & EN62233:2008

Installation Examples

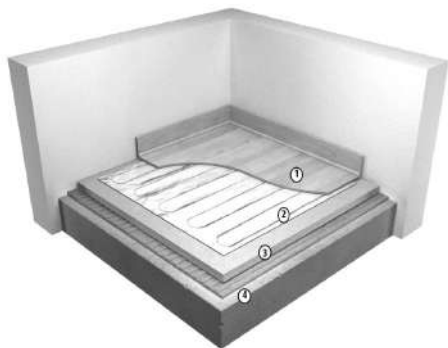

1. Wood/ Laminate flooring
2. Warmup® Foil Heater
3. Soft Insulation Material
4. Subfloor

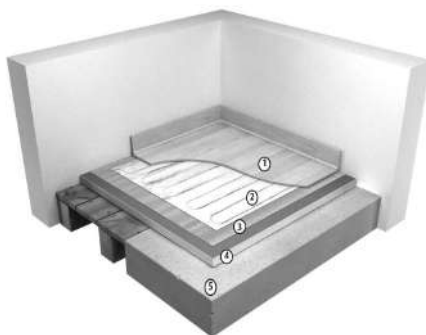

1. Wood/ Laminate flooring
2. Warmup® Foil Heater
3. Underlay
4. Warmup® Insulation Board
5. Subfloor

The Foil Heaters must not be installed in thinset cement or in direct contact with a cement or concrete slab. The heater must be installed on top of a suitable soft Insulation material. The Warmup® Insulation board may be used if additional levels of insulation are required but a soft underlay will need to be installed on top of the board.

If a vapour barrier is to be installed it should be laid below the insulation and not on top of the heater.

Product Data

140W

Model	Area (m ²)	Length (m)	Width (m)	Total Watts	Amps	Total Resistance
WLFH-140W/140	1	2	0.5	140	0.61	377.86
WLFH-140W/210	1.5	3	0.5	210	0.91	251.90
WLFH-140W/280	2	4	0.5	280	1.22	188.93
WLFH-140W/420	3	6	0.5	420	1.83	125.95
WLFH-140W/560	4	8	0.5	560	2.43	94.46
WLFH-140W/700	5	10	0.5	700	3.04	75.57
WLFH-140W/840	6	12	0.5	840	3.65	62.98
WLFH-140W/980	7	14	0.5	980	4.26	53.98
WLFH-140W/1120	8	16	0.5	1120	4.87	47.23
WLFH-140W/1260	9	18	0.5	1260	5.48	41.98
WLFH-140W/1400	10	20	0.5	1400	6.09	37.79
WLFH-140W/1680	12	24	0.5	1680	7.30	31.49

80W

Model	Area (m ²)	Length (m)	Width (m)	Total Watts	Amps	Total Resistance
WLFH-80W/80	1	2	0.5	80	0.35	661.25
WLFH-80W/120	1.5	3	0.5	120	0.52	440.83
WLFH-80W/160	2	4	0.5	160	0.70	330.63
WLFH-80W/240	3	6	0.5	240	1.04	220.42
WLFH-80W/320	4	8	0.5	320	1.39	165.31
WLFH-80W/400	5	10	0.5	400	1.74	132.25
WLFH-80W/480	6	12	0.5	480	2.09	110.21
WLFH-80W/560	7	14	0.5	560	2.43	94.46
WLFH-80W/640	8	16	0.5	640	2.78	82.66
WLFH-80W/720	9	18	0.5	720	3.13	73.47
WLFH-80W/800	10	20	0.5	800	3.48	66.13

Compatible Wood Laminates

Please ensure that your laminate flooring is suitable for use with electric underfloor heating. Most wood / laminate floors are compatible with the Foil mats but we do not recommend using any wood flooring thicker than 18mm.

Wood flooring with metallic strips as part of their locking systems are **NOT** compatible as these metallic strips may damage the Foil mats.

Any wood floor with a pad already attached must not be used with the Warmup® Foil mats.

For a wooden floors or similar the thermal resistance should not exceed $0.15\text{m}^2\text{K/W}$.

Compatible Insulation Materials

The Foil Heaters **MUST NOT** be installed in thinset cement or in direct contact with a cement or concrete subfloor. The heater **MUST** be installed on top of a suitable soft Insulation material. This is necessary to prevent the heater from being damaged when the weight of the floor furniture and people are added.

The insulation material should be at least 6mm thick and suitable for use with electric underfloor heating.

It is important that you take into account the insulation properties, the better R value the shorter the heat up time.

If using the Warmup® Insulation board or similar a soft underlay must be used to ensure the heater is not in contact with the cement facing of the board.

NOTE: Underlayment papers are not compatible with Warmup® Foil mats.

Cutting and turning the mat:

In some instances, you may need to cut turn and flip the mat to suit the room. It is essential that you do not cut, twist or kink the heating wire.

To make a cut separate the foil sheets at the long edge of the heater to expose the heating cable loops. Lift the cable out of the way when cutting. Once aluminium foil has been cut and the mat has been repositioned, use the aluminium foil strips provided to cover the exposed cable and link the pieces of the mat.

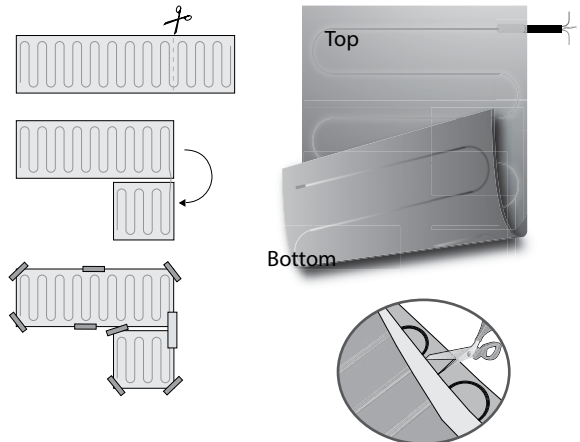

Electrical Requirements

As with all electrical projects which are subject to Part P, all electrical work must be carried out by a certified electrician. All work must conform to the current IEE wiring regulations - BS7671:2008.

The system must be protected by a dedicated 30mA RCD at all times. For systems not exceeding 13 amps a fused spur or 30mA RCD/spur that has contact separation in all poles that provides full disconnection under over-voltage category III conditions must be used.

For systems larger than 13 amps a suitable protective device that meets the current wiring regulations must be used.

Connecting the thermostat

The thermostat should be installed in the room to be heated. In the case of bathrooms or wet areas a electrician should be consulted regarding whether a suitable zone is available.

The thermostat can handle a load up to 16 amps. For larger installations exceeding 16 amps multiple thermostats may be required or it may be possible to use a Contactor.

Once all of the connections have been made, the electrician must complete the relevant forms and display at the fuse board as per BS7671:2008 Section 753.

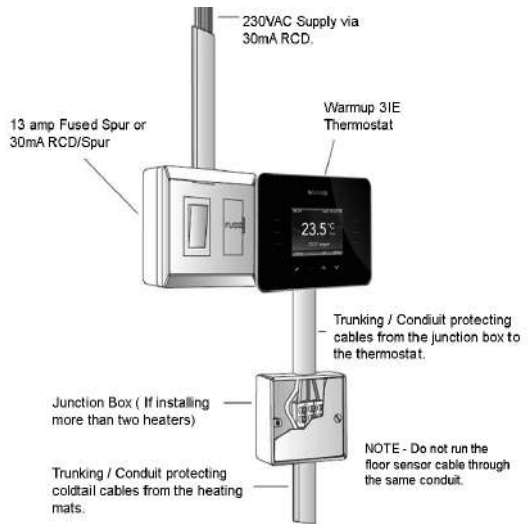

Testing the heating element

A resistance tests should be carried out on the heating mat before, during and after fitting the final floor covering.

Using a Multi-meter set at 2K ohms test across

- Live to neutral = ohms value as listed on Page 6

If you do not get the expected results or at any time you believe there may be a problem, please contact Warmup's Technical Team for guidance.

Record the readings on the control card at the back of the manual.

NOTE: Ensure that the floor sensor is tested before the final floor finish has been laid. The floor sensor values can be found in the thermostat instructions. When testing the floor sensor ensure that the meter can read up to 20k ohms.

Step 1: Planning Your Installation

Before installing, draw an installation plan showing the placement of the mats, floor sensor, and junction box or boxes.

The Foil heating mats should cover at least 80-90% of the floor area of your room to be used as a primary heat source*.

Choose the combination of heating mats that best enables you to cover the recommended 80-90% of your room. Plan to use the larger foil heating mats as much as possible and to use smaller mats only as gap fillers.

Note: The mats are supplied with a 3 metre long electrical cold lead. If you need longer connection leads, these may be extended consult a qualified electrician.

*Depending on insulation, air-flow & overall heat-loss within the room, additional heating may be required.

It is important to keep an accurate record of where the mats are installed.

Step 2: Check and prepare the subfloor



The Foil heater **MUST NOT** be installed in thinset cement, or in direct contact with a cement or concrete subfloor.

There must always be a soft insulation / underlay beneath the aluminium heating mats.

Carefully inspect the subfloor and make sure it is clean, free of sharp edges, protruding nails and any other materials that may damage the heating mat.

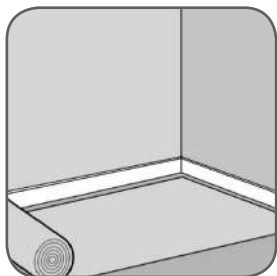

Lay the Insulation as per the manufacturer instructions.

If you are using the Warmup® insulation board you will need to install a soft underlay on top of the boards.

Remove the foil heating mat from the packaging and check the mats visually for any damage.

Test using a multi-meter and verify the correct resistance against the table on page 6. Record the readings on the control card at the back of the manual.

Step 3: Laying Out Your Heating Mats

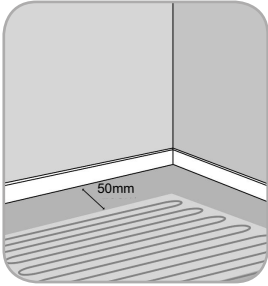

Roll out the foil heating mats on top of the insulation material. Keep the heating mat at least 50mm from the edges of the room.

Ensure that the heating mat is completely flat. Care should be taken not to fold or crease the mats at any time during installation.

Position it in such a way that the power cord will be able to reach the point where the thermostat will be connected.

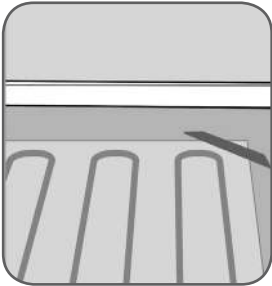

If fitting more than one foil heating mat ensure that the mat does not overlap, as overheating will result. Leave a gap of at least 20mm between each mat.

Secure the foil mat to the underlay using tabs of duct tape to hold the mat in position.

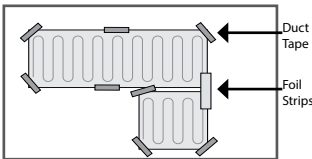

If any of the wire has been detached from the foil mat (when the mat is cut and turned) the wire **MUST** be covered by the aluminium strips. The aluminium strips should also be used to bridge the gap between the sections of the mat.

NOTE: This is essential in order to keep the earth circuit intact.

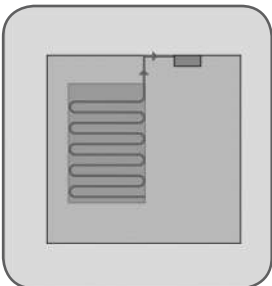

Secure the mats to the floor with tabs of duct tape. Since the joint and the cold tail leads are slightly thicker than the rest of the mat, you will need to create a slight groove in the insulation to ensure the heating mat lays flat. Do not allow the power supply cable to cross or come into contact with the heating mat.

Once the heater(s) have been laid mark each pair of coldtail leads coming from the same mat with a numbered sticker. This will make it easier to identify each mat once the floor covering is laid.

Step 4: Install the thermostat floor sensor



Position the sensor approximately 300mm into the heated area in-between the heating wires runs on the mat.

Do not allow the sensor tip to come into contact with any of the heating element wires.

Warmup recommend the use of conduit when installing the floor sensor. The conduit will protect the sensor and will allow for easier replacement should there be a problem after flooring has been laid.

Run the sensor cable back to the thermostat. The sensor wire **MUST** not cross over the foil heater wires.

Test the floor sensor using a multi-meter. The floor sensor ohms reading values can be found in the thermostat instructions.

Step 5: Install the floor

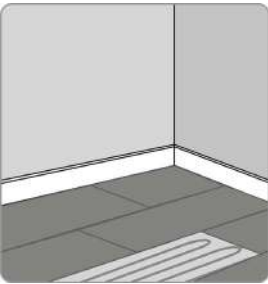

Before fitting the final floor covering test the heating mats to ensure that they have not been damaged during installation. See page 8 for details.

You are now ready to lay the final floor finish. Take care not to damage the heating mats. Do not drive nails or screws into the floor or cut the floor panels on top of the heater.

If the floor is not being laid immediately, all heating mats must be protected with cardboard to prevent damage. Immediately prior to the floor being laid, test the heating mat to ensure it has not been damaged.

Step 6: Connect the thermostat



Once the flooring has been installed, connect the thermostat ensuring that it is set to reach a maximum temperature of 27°C.

A Warmup® thermostat with a floor sensor **MUST** be used in order to accurately monitor the floor temperature and your comfort level.

Always zone each room with a foil heating system with its own thermostat controller. This allows each room to be controlled individually saving you energy by only heating the zone when required.

WARNING:

ELECTRICAL WORK WHICH IS SUBJECT TO PART P BUILDING REGULATIONS MUST BE CARRIED OUT BY A QUALIFIED ELECTRICIAN.

ALL WORK MUST CONFORM TO THE CURRENT IEE WIRING REGULATIONS.

Floor Plan

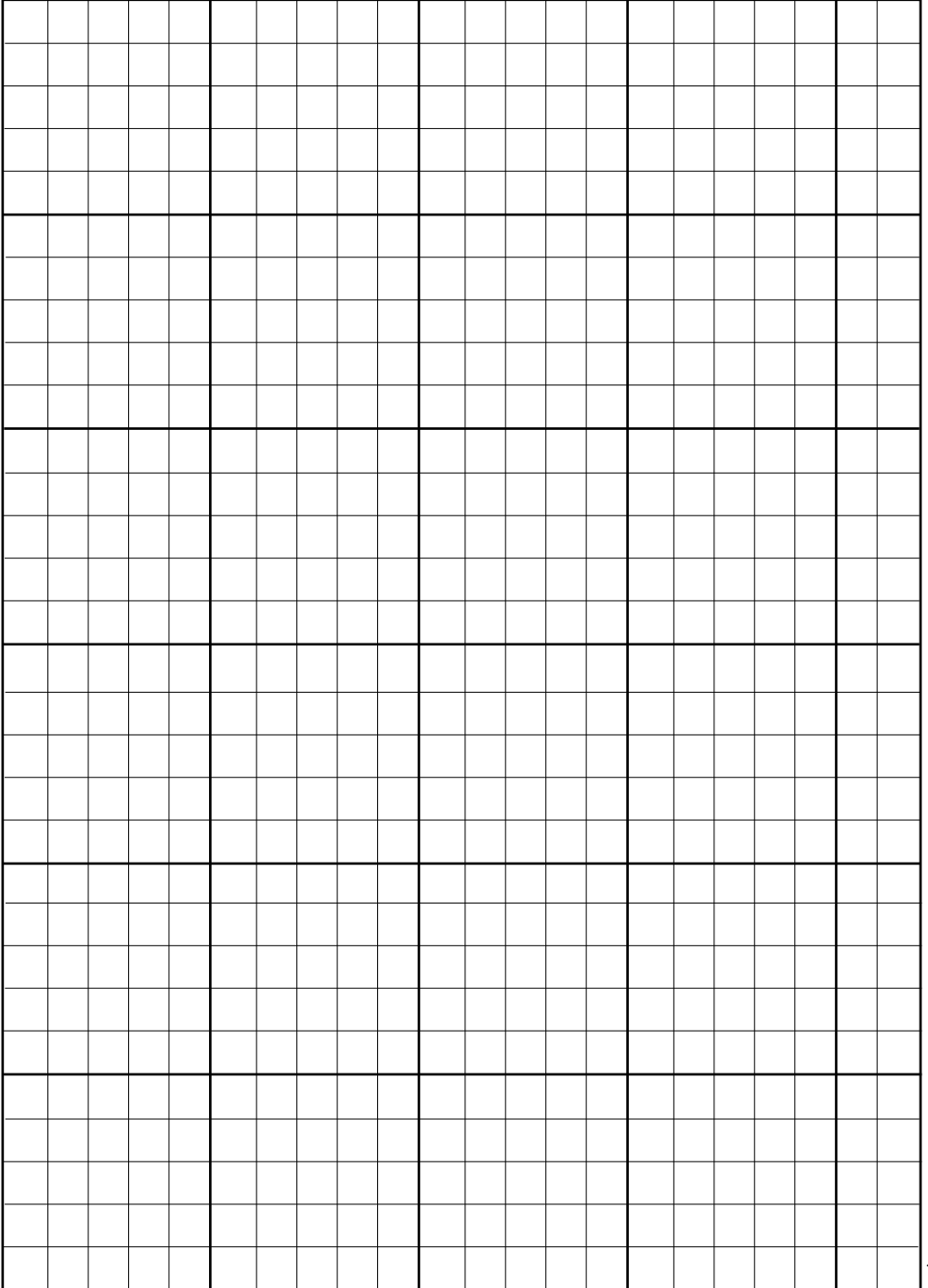

Warranty



Terms and conditions apply

REGISTER YOUR HEATER ONLINE AT: www.warmup.co.uk

THE 15-YEAR ELEMENT OF THIS GUARANTEE DOES NOT EXTEND TO THERMOSTATS WHICH ARE COVERED BY A 3 YEAR GUARANTEE. THIS GUARANTEE DOES NOT AFFECT YOUR STATUTORY RIGHTS.

Warmup® Foil Heater is guaranteed by WARMUP PLC ("Warmup") to be free from defects in materials and workmanship under normal use and maintenance, and is guaranteed to remain so subject to the limitations and conditions described below.

The Warmup® Foil Heater is guaranteed for 15 Years from the date of purchase against manufacturing defects. The 15 year guarantees applies:

1. Only if the unit is registered with Warmup within 30 days after purchase. Registration can be completed online at www.warmup.co.uk. In the event of a claim, proof of purchase is required, so keep your invoice and receipt - such invoice and receipt should state the exact model that has been purchased ; and
2. Only if the heater has been earthed and protected by a 30mA RCD at all times.

Thermostats are guaranteed for a period of 3 YEARS from the date of purchase.

Neither guarantee continues if the floor covering over the heater(s) is damaged, lifted, replaced, repaired or covered with subsequent layers of flooring.

This guarantee period begins on the date of purchase.

Registration is confirmed only when confirmation is sent by Warmup PLC.

During the period of guarantee Warmup will arrange for the heater to be repaired or (at its discretion) have parts replaced free of charge. The cost of repair or replacement is your only remedy under this remedy under this guarantee which does not affect your statutory rights.

Such costs does extend to any cost other than direct costs of repair or replacement by Warmup and does not extend to costs of relaying or repairing any floor covering or floor.

If the heater fails due to damage caused during installation or tiling, this guarantee does not apply. It is therefore important to check that the heater is working (as specified in the installation manual) prior to installing the final floor finish.

WARMUP PLC SHALL IN NO EVENT BE LIABLE FOR INCIDENTAL OR CONSEQUENTIAL DAMAGES, INCLUDING BUT NOT LIMITED TO EXTRA UTILITY EXPENSES OR DAMAGE TO PROPERTY.

Warmup PLC is not responsible for :

1. Damage or repairs required as a consequence of faulty installation or application.
2. Damage as a result of floods, fires, winds, lightning, accidents, corrosive atmosphere or other conditions beyond the control of Warmup PLC.
3. Use of components or accessories not compatible with this unit.
4. Products installed outside the United Kingdom.
5. Normal maintenance as described in the installation and operating manual.
6. Parts not supplied by Warmup.
7. Damage or repairs required as a result of any improper use, maintenance, operation or servicing.
8. Failure to start due to interruption and /or inadequate electrical service.
9. Any damage caused by frozen or broken water pipes in the event of equipment failure.
10. Changes in the appearance of the product that does not affect its performance.



SafetyNet™ Installation Guidelines :

If you make a mistake and damage the new heater before laying the floor covering, return the damaged heater, to Warmup within 30 DAYS along with your original dated sales receipt. WARMUP WILL REPLACE ANY HEATER (MAXIMUM 1 HEATER) WITH ANOTHER OF THE SAME MAKE AND MODEL-FREE.

PLEASE NOTE:

1. Repaired heaters carry a 5 year warranty only. Under no circumstances is Warmup responsible for the repair or replacement of any flooring.
2. The SafetyNet™ Installation Guarantee does not cover any other type of damage, misuse, or improper installation due to improper adhesive or subfloor conditions. Limit of one free replacement heater per customer or installer.
3. Damage to the heater that occurs after laying the floor covering is not covered by the Safety Net™ Installation Guarantee.

Register your Warmup® Warranty online at www.warmup.co.uk

Place this card in a visible spot close to the consumer unit.



Heater Location _____

Total Wattage _____

CAUTION
 Radiant Floor Heating Systems
 Warning-Risk of electric shock
 Electric-wiring and heating panels
 contained below the floor. Do not
 penetrate with nails, screws, or similar
 devices. Do not restrict the thermal
 emission of the heated floor.

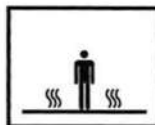

Attention:

Do **not** cut or shorten the heating element.

Ensure that the entire heating elements including the joints are installed under the tiles in the installation.

The Heating element must be used in conjunction with a 30mA RCD.

Heater Model	Resistance Before	Resistance After	Insulation Resistance

_____ Date

_____ Signed

_____ Company stamp/name

This form must be completed as part of the Warmup Guarantee. Ensure that the values are as per the instruction manual.

This card must be situated close to the consumer unit in a visible place.

Note: Draw a Plan showing the layout of the heater.

Warmup Plc
702 & 704 Tudor Estate, Abbey
Road, London
NW10 7UW

T: 0345 345 2288
F: 0345 345 2299
E: www.warmup.co.uk