

INTRODUCTION	3
Electrical Specification	3
THERMOSTAT AND SENSOR LOCATION	4
Thermostat location	4
Location and installation of floor sensor	4
INSTALLATION	5
Normal electrical installation	6
Mounting thermostat into the wall box	7
PROGRAMMING	8
Introduction	8
Icons	9
Getting started	11
Programming the thermostat	11
Selecting operation mode	13
INSTALLER SETTINGS	14
TROUBLESHOOTING	16
WARRANTY	17

The **tempo** thermostat is designed to aid in the comfort of your home by providing timed regulation of your Warmup underfloor heating system.

The thermostat is designed to receive temperature input signals from the following sensors:

1. Air sensor located inside the thermostat
2. Floor sensor installed in the floor to be heated (see Warmup heater instructions for details)

The thermostat is not a safety device and should only be used with Warmup heating products.

In order to avoid damaging your flooring the correct floor type must be selected during the thermostat programming process.

ELECTRICAL SPECIFICATION

Supply voltage:	230V +/-15%, 50Hz
Maximum Switch Load:	16 A, ~3600W
Sensor:	NTC : 10K @ 25°C
Insulation Class:	II
Housing:	IP32
Standards:	EN60730-1 and EN60730-2-9

Meets LVD and EMC directives for safety and electromagnetic compatibility

Note: Thermostat is not designed for use with intermittent power supply.

THERMOSTAT LOCATION

The thermostat should be installed inside a single gang electrical wall box that is at least 32mm deep. For optimal performance, the thermostat should be located in an area with good ventilation. It should not be installed beside a drafty window/door, in direct sunlight or above another heat generating device (e.g. Radiator or TV). The thermostat is designed for operation between 0°C and 50°C with relative humidity less than 80%.

LOCATION AND INSTALLATION OF FLOOR SENSOR

The optimum location of the floor sensor is described in each Warmup heater installation manual. Refer to that manual when selecting floor sensor location.

Warmup recommends the use of conduit when installing the floor sensor. The conduit will protect the sensor and will allow easier repair of the sensor in the case of sensor damage after flooring has been laid.

ⓘ IMPORTANT SAFETY NOTE

This product uses mains voltage electricity and work should only be carried out by a qualified electrician. You should always isolate the power supply before attempting to install or repair the tempo thermostat. The thermostat should not be put into operation unless you are certain that the entire heating installation complies with current general safety requirements for electrical installations. Electrical installation must be in accordance with the latest IEE Wiring Regulations and appropriate Statutory Regulations.

Separate the front housing of thermostat from the wall module:

1. Unscrew both closing screws (bottom of thermostat).
2. Release front housing by gripping the lower half of outer frame and pulling outwards then upwards.
3. Place front housing somewhere safe.
4. Run all wires to the wall box. Check to ensure that you have included the following:
 - Power (Live and Neutral)
 - Heater (Live and Neutral)
 - Floor sensor
 - Fil pilote (France only)
5. Pull wires through the wall box and complete terminal wiring.

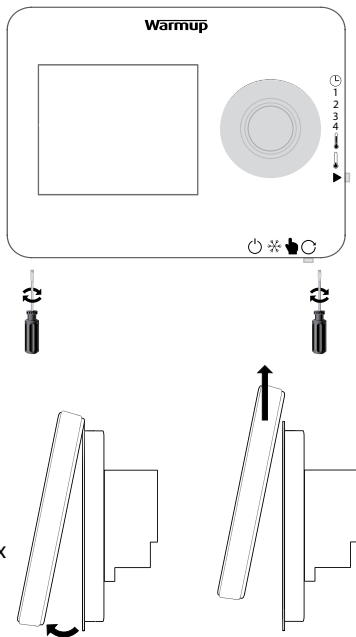

ⓘ IMPORTANT

Ensure that multi strand wires are fully inserted into the terminal and secured tightly. Any loose strands should be trimmed as they could cause a short-circuit.

Note: If connecting more than two heaters, an electrical junction box will be required.

NORMAL ELECTRICAL INSTALLATION

(see diagram)

1. Connect to Fil Pilote (F.P.) - only for use in France
2. Connect to Power Supply (Live – MAX 240V)
3. Connect to Power Supply (Neutral – MAX 240V)
4. Connect to Warmup heater(s) (Neutral – MAX 3600W/ 16 Amps)
5. Connect to Warmup heater(s) (Live – MAX 3600W/ 16 Amps)
6. Not Used
7. Connect to 1st wire of floor sensor (colour not important)
8. Connect to 2nd wire of floor sensor (colour not important).

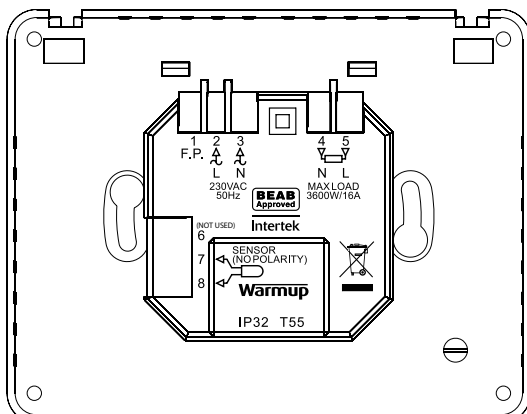

MOUNTING THERMOSTAT INTO THE WALL BOX

1. Push excess wire back through the wall box and insert thermostat back module into wall box.
2. Put fixing screws through mounting holes and tighten.
3. Ensure that thermostat is straight before tightening completely.
4. Replace thermostat front housing.
 - Align and sit front housing on to hinges
 - Push lower half of front housing until a 'click' is heard
5. **IMPORTANT:** Tighten both retaining screws.

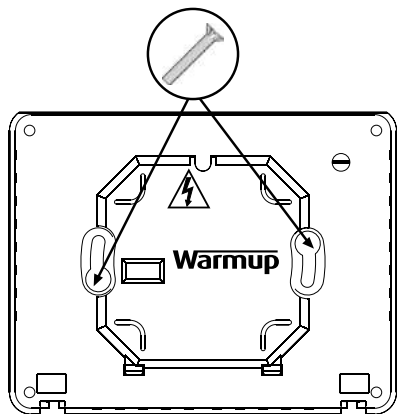

You can now power-up the thermostat and begin the programming process.

INTRODUCTION

The tempo has been designed with simplicity in mind and is highly intuitive in its programming. The sliders and simple rotary control make the setting of the thermostat quick and easy.

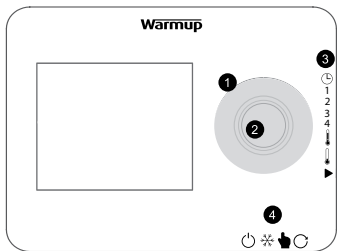

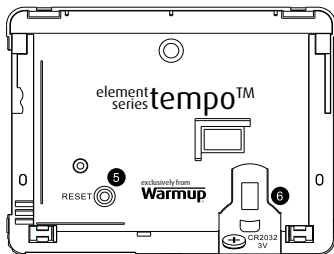

- (1) Rotary Control (Turn clockwise to increase and anti clockwise to decrease.)
- (2) Main Button
- (3) Program Slide control (only used during programming)
- (4) Mode Slide control
- (5) Reset Button
- (6) Replaceable CR2032 battery



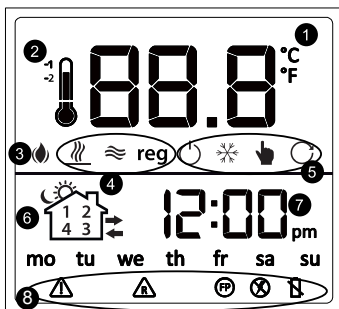

ICONS



1	Normally shows the current temperature in the room. This can be either the floor temperature or the air temperature. (See icon 4). When you are setting a program or manual temperature this icon will temporarily show the set temperature.
2	During programmed operation this thermometer will show whether the thermostat is at "Comfort" or "Setback" temperature. The icon will be displayed when "Comfort -1/-2 is the target temperature. (Only used with the Fil Pilote)
3	The icon is displayed when the heating is on.
4	These icons show the type of temperature regulation being used Floor sensor:  Air sensor:  Regulator reg (This mode should only be used in special situations, please contact Warmup for additional information).

- 5 These icons show the mode in which your thermostat is being used

 Program mode will run the scheduled program

 Manual mode will hold a fixed temperature

 Frost Protection will limit the temperature to fall below 5°C

 Standby mode

Note: When the thermostat displays both the manual and comfort icon the thermostat is in a manual override and will hold a fixed temperature until the next scheduled program period.

- 6 These icons show which time of day is being programmed



morning



day



evening





night

- 7 This area shows the current time and day of the week

- 8 These are error icons (see trouble shooting section) or special command icons:

 Fil pilote

 Floor sensor error

 Overheat limit has been reached

 There is no mains power

 Battery is low

GETTING STARTED

In order to program the **tempo** thermostat all you need to do is slide the **Program Slide** control from the top position to the bottom position, customising the program along the way.

If you make a mistake, return the **Program Slide** control to the previous position and start again. In order to change a setting value, turn the **Rotary Control**. Pressing the **Main Button** will accept the value and move you on to the next value that needs setting.

The **tempo** thermostat has a number of “**Installer Settings**”. If your thermostat has been installed correctly and is working then it is unlikely that you will need to change these again. For additional details see “**Installer settings**” section.

Your thermostat can be set so that the programming is done for:

- „all days the same“
- „weekday and weekend“
- „7 day“

To change this setting, see the “**set time/day**” section.

PROGRAMMING THE THERMOSTAT

To program your thermostat all you need to do is move the **Program Slide** control on the right hand side of your thermostat from top to bottom. The table below will explain what you can do at each step.





Set Time / Day		Turn the Rotary Control to change the current clock time. Once the clock time has been set, press the Main Button , you will now be able to set the day of the week. Turn the Rotary Control to select the correct day.
-------------------	---	--

		<p>Your thermostat will by default allow you to set a weekday and weekend program (5-2d). If you would like to set "all days the same" (1d) or "7 day" programs (7d) then hold the Main Button for 5 seconds whilst in the set time/day slide position. Once in this mode, turning the Rotary Control will allow you change this setting. Push the Main Button or move the Program Slide to accept the value.</p> <p>Once you have set the time and day, move the Program Slide to the next position to accept the value.</p>
Set Timing	<p>1</p> <p>2</p> <p>3</p> <p>4</p>	<p>When in any of these positions you can set the start time for "morning" (1), "day" (2), "evening" (3) and "night" (4) periods.</p> <p>The "morning" and "evening" periods will follow the comfort temperature, "day" and "night" periods will follow the setback temperature.</p> <p>Using the Rotary Control, select the start time and press the Main Button to move to the next day.</p> <p>If you hold the Main Button for 3 seconds it will copy the start time to the next day..</p> <p>Note: If you want to set the thermostat so that it is keeping the comfort temperature all day and only setback at night, then just set the "day" start time equal to the "evening" start time.</p>
Set temperature		<p>Here you can set the temperature which will be used for the comfort and setback temperatures.</p>

Done		Move the Program Slide control to the lowest position in order to start your thermostat. Heating will not occur if the Program Slide control is not in this position.
------	---	---

SELECTING OPERATION MODE

The thermostat can be set to run a program, hold a fixed temperature, efficiently protect your home from freezing or standby. You can select these modes by moving the **Mode Slide** control on the bottom of the thermostat.



Standby		The thermostat will not come on. Note: The thermostat is still connected to the mains electricity supply and your heating system is not isolated. Always isolate from the mains before undertaking any maintenance.
Frost Protection		The thermostat will not let the temperature fall below 5°C
Manual		The thermostat will hold a fixed temperature. Just turn the Rotary Control to change the temperature.
Auto		In this position your thermostat will run the program you have set. If you would like to temporarily adjust the temperature, just turn the Rotary Control . At the start of the next heating period, your thermostat will automatically resume your programming schedule.





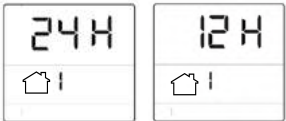

INSTALLER SETTINGS

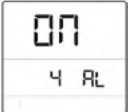

These are settings that should be set by the installer of the thermostat and are unlikely to need to be changed again during the product's life.

To enter the installer setting mode, remove the thermostat from the wall plate. Press and hold the **Main Button** and, using a pointed device, press and release the **Reset Button** on the back of the thermostat. After 5 seconds release the **Main Button** on the front of the thermostat.

Once in the installer setting mode you can turn the **Rotary Control** to change your selection and press the **Main Button** to accept your setting and proceed to the next step. Once you have completed all the steps you will automatically exit the installer setting mode.

	Setting Configured	Default Value	LCD Example
1	Change clock format (12/24)	24	
2	Change unit of measurement (°C/°F)	°C	
3	Change sensor used to target temperature (Floor/ Air/ Regulator)	Floor	
<p>Note: In regulator mode the thermostat will run for a set number of minutes in a 10 minute cycle</p>			

4	Set Floor Sensor Type (NTC10K/NTC12K)	NTC10K											
5	Decide whether the thermostat uses Adaptive Learning to pre heat the room for your schedule	ON	 										
6	Fil Pilote (France only)	OFF	 										
7	Set Overheat limit to protect your floor Note: the tempo will only allow you to set a temperature 2°C lower than the Overheat limit	30°C	 <p style="text-align: center;">Maximum Overheat Limits</p> <table border="1" style="width: 100%; border-collapse: collapse;"> <tbody> <tr> <td>Tiles</td> <td>40°C / 104°F</td> </tr> <tr> <td>Stone</td> <td>40°C / 104°F</td> </tr> <tr> <td>Wood / Laminate</td> <td>28°C / 86°F</td> </tr> <tr> <td>Carpet</td> <td>28°C / 86°F</td> </tr> <tr> <td>Vinyl</td> <td>28°C / 86°F</td> </tr> </tbody> </table>	Tiles	40°C / 104°F	Stone	40°C / 104°F	Wood / Laminate	28°C / 86°F	Carpet	28°C / 86°F	Vinyl	28°C / 86°F
Tiles	40°C / 104°F												
Stone	40°C / 104°F												
Wood / Laminate	28°C / 86°F												
Carpet	28°C / 86°F												
Vinyl	28°C / 86°F												
8	Set an offset value to calibrate the temperature reading of your thermostat sensors	0°C	 										

Error message	Description / Solution
The thermostat is not controlling the temperature	Ensure that the Program Slide is in the run position (lowest point) and that the Mode Slide control (bottom) is in the manual or program positions
Floor sensor error	If the floor sensor error icon  or “-” appears on the screen it means that your thermostat has been unable to detect the temperature of the floor. Please contact Warmup.
Overheat	If you see the overheat icon  it means that your floor has become too hot and the heating has been suspended. Please contact Warmup.
Low battery	The low battery icon  will display when the battery needs to be replaced. The thermostat must be connected to the mains electricity supply in order to work, it is not designed to be used with an intermittent power supply. If the battery is not installed then your thermostat will not be able to maintain the clock time if power is lost.
Heating starts too early	If your heating is coming on too early, then this may be because the Adaptive Learning function is turned on. This function allows your thermostat to learn how long it will take to heat up to ensure it is the correct temperature at the start of the comfort periods. See “installer settings” section of this guide

Error message	Description / Solution
Incorrect calibration	The thermostat should not need any calibration, however if you would like to apply an offset to the temperature settings see the "installer settings" section.
No mains electricity	The icon  means that the thermostat is not receiving power. Check that the thermostat logic module is properly installed on the power module and that the 230V mains electricity supply is connected.
Regulator mode (reg)	In this mode the thermostat will work for a set number of minutes in a 10 minute cycle. The thermostat will not use the temperature for control. Please contact Warmup for additional details.
Fil Pilote (FP)	The thermostat can obey the 6 standard commands of fil pilote (pilote wire). Please contact Warmup for additional details. (France only).
"HI" or "LO"	The thermostat will display "HI" if the ambient temperature exceeds 50°C (122°F) and "LO" when the ambient temperature falls below 0°C (32°F).

WARRANTY

Warmup plc warrants this product, to be free from defects in the workmanship or materials, under normal use and service, for a period of three (3) years from the date of purchase by the consumer. This Warranty does not affect your statutory rights.